

# FreeRider<sup>®</sup>



ATTENTION  
READ ALL PARTS IN THIS  
MANUAL BEFORE OPERATING  
YOUR SCOOTER

FR510DX2/DXs2(FR-D01/D02)



FR168-3/3S  
(FR-S01)



FR168-4/4S/4S2B  
(FR-S03/S04/S06)

## USER'S INSTRUCTION MANUAL



## SAFETY GUIDELINES

**Warning!** An authorised dealer or certified technician must perform the initial setup of this scooter and must perform all of the procedures in this manual.

The symbols below are used throughout this User's Instruction Manual and on the scooter to identify warnings and important information. It is very important for you to read them and understand them completely before using the scooter.



**Warning!** Indicates a potentially hazardous condition/situation. Failure to follow designated procedures can cause either personal injury, component damage, or malfunction. On the product, this icon is represented as a red triangle with red exclamation mark.



**Caution!** Indicates situations where extra caution should be taken. These actions should not be performed at any time or in any circumstances. These actions can cause personal injury and/or equipment damage. On the product, this icon is represented as a triangle with red border.

Please fill out the following information for quick reference:

Freerider dealer: _____
Address: _____
Phone Number: _____
Purchase Date: _____ Serial Number: _____

*Note: This User's Instruction Manual is compiled from the latest specifications and product information available at the time of publication. We reserve the right to make changes as they become necessary. Any changes to our products may cause slight variations between the illustrations and explanations in this manual and the product you have purchased. The latest/current version of this manual is available on our website.*



## FOREWORD

Please read and follow all instructions in this User's Instruction Manual before attempting to operate your scooter for the first time. If there is anything in this manual that you **DO NOT** understand, or if you require additional assistance for setting it up, contact your nearest authorised dealer.

Using your product safely depends upon your diligence in following the warnings, cautions and instructions in this manual.

A full technical specification can be found at the rear of this manual.

Using your scooter safely also depends upon your good judgment and common sense, as well as that of your dealer, caregiver or health professional.



## CONTENTS

Introduction .....	3
Purpose Of Your Scooter .....	3
Rules For Safe Use .....	4
Getting To Know Your Scooter .....	6
Comfort Adjustments .....	7
Operating Your Scooter .....	9
Freewheeling Your Scooter .....	11
Safety Instructions & Warning .....	12
Safety Warning & Instruction Labels .....	17
Learning To Get About .....	18
Care & Maintenance .....	20
Batteries & Battery Charging .....	22
Basic Fault Finding .....	23
Technical Specification .....	26
Classification .....	31
Optional Accessories .....	32
Guarantee Terms .....	33
Service History .....	34



## INTRODUCTION

Congratulations on the purchase of your scooter. Please read this User's Instruction Manual carefully before you attempt to operate your scooter. Your User's Instruction Manual will assist you to get the most from your machine.

This manual contains important information regarding the safe operation and maintenance of your scooter.

If you have any queries concerning operation or maintenance, consult your authorised dealer.

**Please keep in mind that the operator of the scooter is responsible for hazards occurring to other people or their property.**

Your scooter has numerous features not found on other power scooters. With proper care and maintenance, you will enjoy many years of dependable service.

Please remember that when it comes to service and repairs, your authorised dealer knows your scooter best.



## PURPOSE OF YOUR SCOOTER

The scooter provides transportation for an elderly or disabled person. It can be used in a variety of indoor and outdoor settings.

The intended user should possess some degree of ability with the use of both arms and hands, reasonable balance and good eyesight, and a degree of spatial awareness.

The user should have received training in the use of the product, preferably in their normal environment.

Your scooter should not be used in torrential rain or deep snow, on loose slippery surfaces and slopes or on wet grass etc., which could become a danger to the rider, or other road users.

**DO NOT** drive your scooter if you are under the influence of alcohol, drugs or medication that may affect your ability. If you are in doubt, consult your doctor.



## RULE FOR SAFE USE

These symbols below are used in this User's Instruction Manual to identify warnings and cautions. It is very important for you to read and understand them.

**Warning:** Failure to note the warnings in this manual may result in personal injury.

Your scooter is a powerful machine. Please read all of the instructions in this manual before operating your scooter. Follow notes carefully to ensure safety at all times.

**ALWAYS** make certain your machine is fully charged and in full working order before starting your journey.

### **Weight Limitations:**

Your scooter is rated for a maximum weight capacity of 136 kg (300 lbs).

1. **DO NOT** ride your scooter without reading this instruction manual. Also read all of the safety instructions and warning at the start of this manual.
2. **ONLY** drive your scooter if your health condition will allow you to be safe.
3. **DO NOT** exceed the maximum safe gradient outlined for your vehicle.
4. **DO NOT** carry passengers or exceed the maximum carrying weight.
5. **DO NOT** reverse your scooter onto uneven inclines or surfaces. Be cautious when traversing slopes.
6. **DO NOT** drive your scooter in a confined space unless the speed adjustment dial is set low.
7. **DO NOT** turn suddenly at full speed, especially on uneven or sloping ground.
8. **DO NOT** drive your scooter where you cannot safely or legally walk.
9. **DO NOT** drive your scooter unless the seat is locked into the driving position.
10. **DO NOT** drive your scooter over deep, soft terrain (eg. soft earth, deep grass, loose gravel, snow).
11. **DO NOT** drive when under the influence of alcohol or certain drugs which may impair your safety.
12. **DO NOT** climb or descend curbs that exceed the maximum dimension detailed under technical specification of this manual. **DO NOT** turn when negotiating curbs.
13. **ALWAYS** approach obstacles at low speed.

14. **ALWAYS** approach obstacles straight.
15. **ALWAYS** keep your feet on the vehicle when driving.
16. **ALWAYS** proceed carefully while riding, especially as you approach the downgrade of a ramp.
17. **ALWAYS** reduce speed when descending inclines.
18. **ALWAYS** avoid uneven surfaces.
19. **ALWAYS** consult your physician or a therapist if in doubt about your ability to operate a scooter.
20. Transport - **DO NOT** sit on your scooter while it is in a moving vehicle. **ALWAYS** strap down your scooter then transfer to the vehicle seat.
21. The batteries fitted to your scooter are maintenance free and **DO NOT** require topping up with distilled water.
22. **DO NOT** drive your scooter through deep water or clean with a high pressure hose.
23. **DO NOT** drive your scooter through sea sand or sea water, this is very corrosive.  
  
**ALWAYS** wash salt splashing from the metal parts of your scooter with hot soapy water as soon as possible.
24. **DO NOT** drive on motorways, highways (i.e. those with a speed limit of over 50mph), cycle lanes or in bus lanes.
25. **ALWAYS** switch your lights on at night or in poor visibility. Wear reflective clothing.
26. If unintended movement or brake release occurs, turn the scooter OFF as soon as it is safe.
27. Report all incidents of unintended movement or brake release to the scooter local dealer, and note whether there is a source of EMI nearby.

Please remember you are a motorised pedestrian and must observe all rules and regulations of other pedestrians wherever possible. Your scooter has been designed for use on most roads. However, you still must drive it with care and attention. Please read the "**Safety instructions and warning**" section of this manual.

**Please have a safe journey!**



## GETTING TO KNOW YOUR SCOOTER

### FR510DX2/DXs2

- 1 Steering handlebars
- 2 Drive mirror
- 3 Console
- 4 Charging socket
- 5 Basket
- 6 Front light
- 7 Direction indicator lights
- 8 Front and rear bumper
- 9 Amber side reflectors
- 10 Floor mat
- 11 Pneumatic wheels with grey tyres
- 12 Rear lights and indicators
- 13 Adjustable angle seat with backrest



### FR168-4/4S

- 1 Adjustable steering handlebars
- 2 Driving mirror
- 3 Console
- 4 Charging socket
- 5 Basket
- 6 Front light
- 7 Direction indicator lights
- 8 Front and rear bumper
- 9 Amber side reflectors
- 10 Floor mat
- 11 Pneumatic wheels with grey tyres
- 12 Rear lights and indicators
- 13 Adjustable angle seat with backrest



## FR168-3/3S

- 1 Adjustable steering handlebars
- 2 Driving mirror
- 3 Console
- 4 Charging socket
- 5 Basket
- 6 Front light
- 7 Direction indicator lights
- 8 Front and rear bumper
- 9 Amber side reflectors
- 10 Floor mat
- 11 Pneumatic wheels with grey tyres
- 12 Rear lights and indicators
- 13 Adjustable angle seat with backres



Your scooter is delivered fully assembled, fitting the two batteries and the seat assembly together with some minor adjustments are detailed on the following pages, under "Operating your scooter". A full technical specification for your scooter can be found at the rear of this manual. A great deal of thought has gone into the design of your four wheeled vehicle which will allow you to negotiate obstacles found in confined shopping areas. Also, the four wheels will give you added stability on uneven surface. This is just one of the features you will find on your scooter.

Others are:

**COMFORT** - The contoured seat giving you day-long comfort. A fully proportional speed-controller with a speed restriction facility allows you a smooth, safe jerk-free ride.

**Caution: DO NOT** switch "off" the on/off power key when you are moving; this will automatically apply the motor parking brake suddenly and could place you in a dangerous situation. Your scooter is fitted with anti-tipping wheels. **DO NOT** remove these anti-tipping wheels, they are an important part of the scooter design provided specifically for your safety.





## COMFORT ADJUSTMENTS

Before setting out on your scooter, you need to make sure that your seat is in the correct driving position. Your local dealer will set the seat to the correct height for your individual needs. The seat has four basic adjustments to assist your comfort.

**1. Seat Lock Lever:** This allows the seat to swivel through 360°. It can be re-located on the right side for your convenience. Pull up fully to release the seat allowing rotation. Release level to lock the seat into the desired position.



**Warning:** When driving, the seat should be locked in the straight ahead position.



**Caution:** The seat locking level must lock be lifted up fully when rotating the seat, failure to observe this may result in unnecessary wear of the seat post.

Removing seat from Scooter: The seat mounting post is designed with a special safety lifting point, this will prevent the seat from inadvertently dismounting itself in the case only be demounted by turning the 90 the forward driving position.



**Warning:** The seat base has a series of threaded holes for universal mounting, on no account must your scooter seat be relocated from the original factory setting. Failure to observe this warning will put you into an unstable and dangerous situation which could cause you harm.

**2. Armrest Width Adjustment:** On each side at the rear of the seat you will find a large black knob. By simply loosening this knob you are able to slide the armrests in or out to whatever width you desire. Re-tighten the knobs fully. You may need a friend to assist you with this initial setting up operation. This may extend the width of your scooter.



**Caution:** The backrest of your seat will not fully fold forwards if armrests are positioned too closely towards one another.



**Warning:** **DO NOT** drive your scooter with the arms removed or in the raised position.



**3. Armrest Angle Adjustment:** The armrest angle can be adjusted individually to suit your needs. To make adjustments to the armrest angle you will need two 13mm spanners (not provided). Lift the arm upwards, and you will find the adjusting bolt. First loosen the locking nut, rotate the bolt in or out until the required angle is found, lower the arm and check the angle for comfort; re-adjust as necessary. Finally tighten the locking nut.



**Warning:** When lowering the arm make certain clothing or fingers are not positioned under it.

**4. Seat Height Adjustment:** You may need to alter the seat height setting at a later date, please follow these instructions.

- 1) Remove your seat from the scooter by lifting the seat locking lever and lifting the seat clear of the scooter. Note your seat for safety reasons can only be removed when it is Turned 90°. Please take care when lifting heavy weights. Place your seat on a soft clean work area.

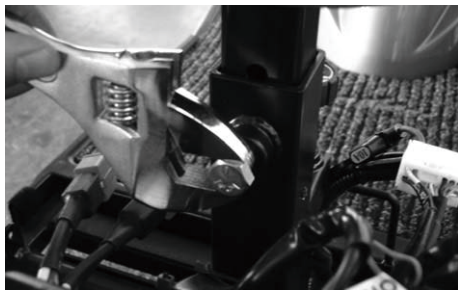

- 2) With the aid of a 17mm spanner (not supplied) loosen the 10mm seat clamp fixing bolt.



- 3) Remove the 10mm fixing bolt and reposition the bolt into one of the four preferred location holes of the seat mounting tube.

- 4) Re-tighten the 10mm fixing bolt. Refit the seat onto your scooter.



**Warning: DO NOT** have the seat set too high, you must be able to place both feet firmly on the scooter's floor area. Stability will be reduced the higher your seat is set on the mounting tube. **ALWAYS** take great care when cornering, lean into the corner to achieve the best stability from your scooter.



**5. Seat Slide Of The Seat:** Located on the right front side of the seat. The lever allows you to adjust your seat forwards and backwards when sitting on the seat. Simply pull up the lever and move in the desired position backward by pushing or forward by hitching. As soon as the lever is released, the seat will lock into the new position.



**Caution:** The best the seat has fully locked by hitching backwards and forwards.



**Warning:** DO NOT carry out this operation when your scooter is moving, first stop apply the brakes and then carry out the seat position.

## CAPTAIN SEAT

The seat as fitted to your scooter, has a fold down backrest. The seat has four height positions similar to those found on the standard seat. Your local dealer set position the seat to allow you the most comfortable driving position.

**6. Backrest Angle Adjustment:** The angle of your backrest can be adjusted to a comfortable driving position by the operation of the lever situated on the left side of your seat. When sitting on your seat, lean backwards against the backrest and at the same time lift the operation lever upwards. Lean forwards or backwards once the locking mechanism has released, positioning the backrest in a comfortable driving position. Releasing the lever will lock the backrest in your chosen position.



**Caution:** Care should be taken during this operation as the backrest mechanism has a strong assisting spring to aid movement.

*Please Note: Damage can result the mechanism if the backrest is not supported during this operation.*

**7. Backrest Height Adjustment:** The upper cushion of your backrest can be adjustment for height, giving you more back support if you are tall, by operating the small latch cushion up or push down for the most comfortable position. The headrest will also lift out for convenience.



## HANDLEBAR ADJUSTMENT

The handlebar of your scooter is designed to allow you to position it in a comfortable driving position. It can be locked into numerous positions or unlocked to move freely for transportation.

The handlebar lock is operated by a black lever positioned on the right hand side of the handlebar. To release the handlebar from a locked position pull the black lever upwards, the handlebar will now move freely, but under mild tension.



To lock the handlebar into a comfortable driving position, simply push the black lever downwards until the handlebar is locked firmly into position.

With the combination of the height adjustment together with the handlebar movement, you should find a suitably comfortable driving position.



**Warning:** ALWAYS make certain the handlebar locking lever is fully down and the handlebar is securely clamped onto the chrome support plates before driving your scooter. To make service adjustment of this part, refer to the Care and Maintenance section of this manual.

# OPERATING YOUR SCOOTER

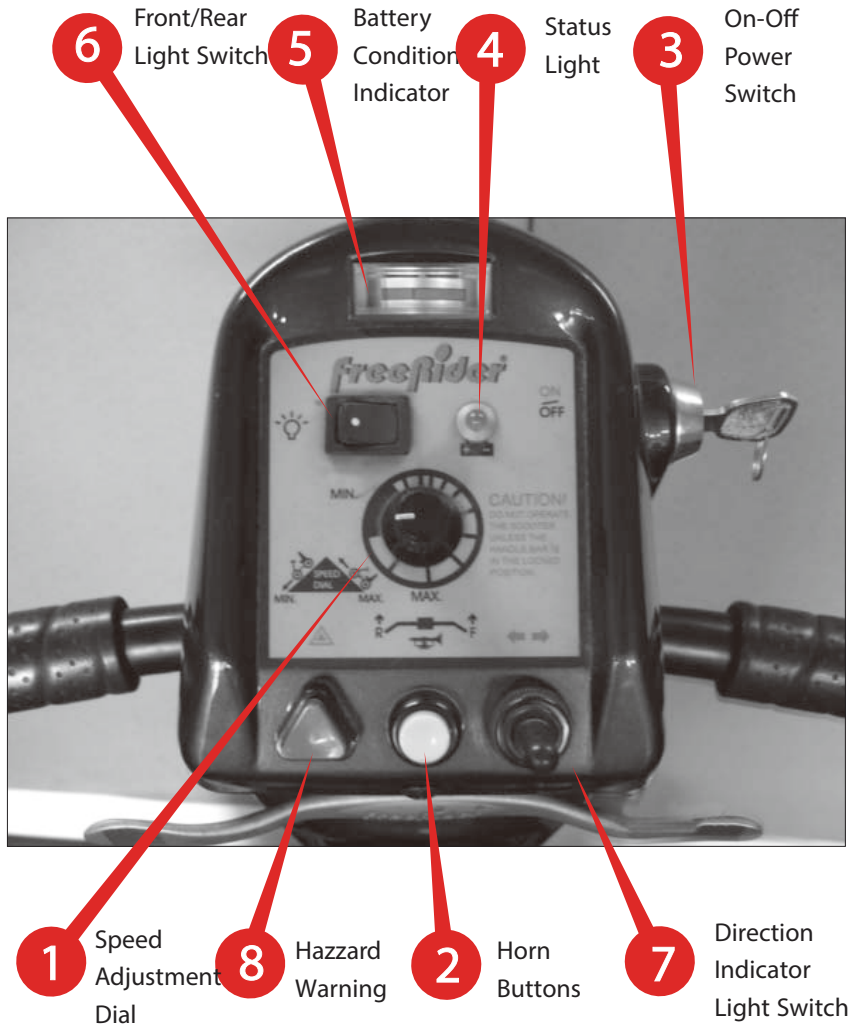

Your controls are located on the handlebar console they are:

**1. Speed Adjustment Dial:** This allows you to pre-select your desired top speed. The dial is proportional to speed and can be set anywhere between minimum ("min") and maximum ("max") increments. Turn the dial knob anticlockwise to minimum for a very gentle operation, and clockwise towards maximum to increase your speed.

*NOTE: When attempting to climb obstacles, you will need to set the dial to a high setting. Remember the higher position you set your speed dial to, the faster your scooter will travel.*

**2. Horn Buttons:** Sounds a polite warning signal.

**3. On-Off Power Switch:** Located at the right side of the control console. Insert the key and turn clockwise. You will note after a second the needle on the battery state indicator moves towards the green sector and the green status light illuminates. Your scooter is now ready to drive. To switch off your machine turn the key anticlockwise. Remove the key when your scooter is left unattended. **DO NOT** attach heavy additional keys to your key ring, the weight can damage the switch unit.



**Caution: DO NOT** switch to "off" when your scooter is moving. Failure to observe this warning will result in the motor brake being applied suddenly and placing you in a dangerous situation.

You should only switch "off" when in motion in the case of an emergency. Continual use in this mode may cause undue stress to the drive system and damage the main electronic speed control unit. Be extremely cautious on slopes. Sit upright in your seat or your machine could become less stable.

**Sleep Time:** When you rest your scooter with the electronics switched "on" you are using valuable battery power. Your scooter will automatically go into a sleep mode to preserve battery energy after approximately 15 minutes, the battery indicator and green status light goes off. To start your scooter again simply switch the key switch to "off" and back to "on" again, your scooter is now ready to go.

**4. Status Light:** When you turn your scooter on, the green light on your console will illuminate at a constant rate. The status light is connected to a very sophisticated diagnostic system which can identify faults which could occur on the main speed control system or some other part of your scooter's electronic drive system. For instance if your batteries run low in power, the status light will flash slowly at one flash a second; this indicates your batteries need recharging.

If you notice the status light flashing at two flashes per second, you are being notified that the battery voltage is too low and you must stop using your scooter at the earliest opportunity.

Your status light has nine similar flashing diagnostic signals, reference to these diagnostic codes is found under "Fault Finding" at the rear of this manual.

**5. Battery Condition Indicator:** Located at the top of your console. When your scooter is switched on, the needle on the gauge will move across the scale from the left "red" sector towards the "green" sector, indicating the state of charge in your batteries. As the power is used up in your batteries the needle will move towards the red sector indicating the state of charge at that precise time. When the needle is fully over to the right (green sector), the batteries are fully charged. When the needle falls towards the red sector your batteries are losing power, but you will still have power to spare. When the needle falls into the red sector your batteries are low in power and need to be re-charged, although you will still have approximately half-an-hours normal flat pavement driving in reserve. It is not recommended to use this power regularly as it will shorten battery life. It is wise to re-charge your batteries when the needle enters the red zone.

*NOTE: When driving up a slope or similar obstacle your scooter will be working hard, the battery gauge will move into the red sector; it will return towards the green sector once the load on your motor is reduced, this does not indicate low batteries.*

**6. Front/Rear Light Switch:** This rocker type switch controls the function of the front and rear lights. Simply push down on the left side (white spot) for "on" and the right side for "off".

**7. Direction Indicator Light Switch:** Located at the bottom right of your console, the direction indicator lights for right and left manoeuvres are controlled by this switch. When making a turning manoeuvre on the road the appropriate switch dissection warning light will flash. To cancel the direction indicator return the switch to the centre position. The left direction indicators are activated by "flicking" the switch to the left.



**Caution:** Please note the direction indicators are not self-canceling.



**Warning:** Please be aware to test the function of your direction light before each journey. Failure to observe this warning could put you and other road users into a dangerous situation.

**8. Hazard Warning:** Positioned to the bottom left of your console, when pressed this red triangular button activates all of the amber flashing direction lights to warn other road users that you are stationary or in distress. This function should only be used in emergencies. You will note that both green direction lights at the top of your console are flashing to warn you the hazard system is in operation. To cancel the hazard warning simply press and release the red triangular button.

### FORWARD, REVERSE CONTROL LEVER (Wig wag)



Located under the handlebar grips. Your speed for forwards and reverse motion and braking is controlled here. The right thumb lever moves your scooter in a forwards direction and also controls the rate of speed by the proportional amount of pressure applied.



The left thumb lever moves the Scooter in a reverse direction and controls the rate of speed by the pressure applied. The lever when released will return itself, and you will gently stop. You will note that you can obtain the reverse of this procedure by pulling the levers backwards with your thumb.



## FREEWHEELING YOUR SCOOTER

If for reasons of convenience, you require to push your scooter for a short distance, the drive system can be put into "freewheel mode". This will allow your scooter to roll freely.

### Freewheel Procedure:

The freewheel device is a red lever located at the rear right hand side of your scooter.

To freewheel your scooter first switch off the power switch located on the scooter's control console.

Pull up the disengage lever until a distinct click is felt. You can now push your scooter with ease.

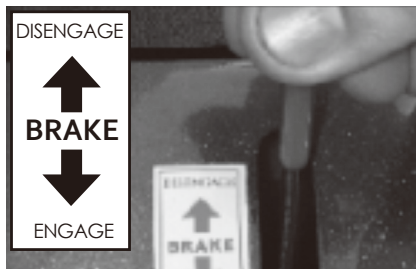

Please note, in this mode with the power switch in the off position, the braking safety system is automatically activated when the scooter is pushed quicker than walking speed, this is an automatic "run away" safety checking system, it also reduces the risk of casual theft.

*Note: The quicker you push your scooter the heavier the brake will be applied.*

To re-engage the drive system, simply push backwards on the red handled lever until a distinct click is felt. Switch the power switch on your console off and then on, the green status light will be fully illuminated and you will be able to drive your scooter once again.



**Warning: DO NOT** sit on your scooter with the freewheel device in the disengage position. Your scooter has limited braking and will not drive in this mode, the green status light on your console will flash five times.



**Warning:** If your scooter is in the freewheel mode when you turn on your power key switch and depress your speed forward - reverse lever, you will not be able to move under motor power. Dismount and re-engage the drive system by pulling backwards on the red handled lever (engage).

Remount your scooter, switch the power switch off and on again until the green status light is fully illuminated. Your scooter will now drive under motor power again.



**Warning: ALWAYS** check that the freewheel device is in the drive position before attempting to drive your scooter after it has been left unattended for a period of time. Failure to observe this warning may result in an accident.

*Note: If you are able to push your scooter the drive system is disconnected, **DO NOT** attempt to drive your scooter. Please check once again the above mentioned procedure for re-engaging the drive.*



**Warning:** If your batteries are disconnected from your scooter, there will be no brake function in the freewheel mode. **DO NOT** leave your scooter unattended in this situation as it could roll away causing damage to other parties or property. **ALWAYS** re-engage the drive system when left unattended.



## SAFETY INSTRUCTIONS & WARNING



**Warning: DO NOT** attempt to operate your new scooter for the first time without completely reading and understanding all of the facts in this User's Instruction Manual.

Your scooter is a state-of-the-art device designed to enhance and increase your mobility.

Dealer provides a range of scooters to best suit the individual needs and circumstance of the scooter user.

Please be aware that the final selection and purchasing decision regarding the model of scooter to be used is the responsibility of the scooter user who is capable of making such a decision with assistance from his/her healthcare professional (i.e. medical doctor, physical therapist etc.) The contents of this User's Instruction Manual are based on the expectation that the mobility device expert has properly fitted the scooter to the user and has assisted the prescribing healthcare professional and/or the authorised dealer in the instruction process for the safe use of the scooter.

There are certain situations, including some medical conditions, where the scooter user will need to practice operating the scooter in the presence of a trained attendant. A trained attendant can be defined as a family member or care professional specially trained in assisting a scooter user in various daily living activities.

When you begin to use your scooter, you will probably encounter situations in which you will need some practice. Simply take your time and you will soon become confident and in control as you maneuver through doorways, on and off elevators, up and down ramps and over moderate terrain. Below are some tips, precautions and other safety measures that will help you to become accustomed to the safe operation of your scooter. Your scooter is fitted with a number of "Safety Warning Instruction" labels. These labels communicate important warnings or instructions. Please familiarise yourself with their location.

Get to know the feel of your scooter and it's capabilities. Dealer recommends that you perform a safety check before each use to make certain your scooter operates smoothly and safely. For details on how to perform these necessary inspections, see the "Care & Maintenance" section of this manual. Perform the following inspection prior to using your scooter.

- (1) Check all battery connections, making certain they are tight and not corroded.
- (2) Check front basket is fitted correctly.
- (3) Check batteries have been fully charged.
- (4) Check operation of brakes.



**Warning: DO NOT** carry passengers on your scooter. Your scooter is designed for a single occupant which complies with legal requirements for pavement vehicles. Carrying passengers on your scooter may result in personal injury and/or property damage.





**Warning:** Exceeding the weight limit will void your warranty and may result in personal injury and damage to your scooter. Dealer will not be held responsible for injuries and/or property damage resulting from failure to observe these weight limitations. Please also remember when carrying heavy objects that this will increase your weight and may make your scooter unstable.

**Cornering:** Excessively high cornering speeds can create the possibility of tipping. Factors which affect the possibility of tipping include, but are not limited to, cornering speed, steering angle (how sharply you are turning), uneven surfaces, included surfaces (such as heavily cambered pavements), riding from an area of low traction to an area of high traction (such as passing from grass areas to a paved area - especially at high speed while turning), and abrupt directional changes. **DO NOT** corner at high speed! If you feel that you may tip over in a corner, reduce your speed and steering angle to prevent your scooter from tipping.



**Warning:** When cornering sharply, reduce your speed. When using your scooter at higher speeds, anticipate changes in the road surface. This will greatly reduce the possibility of a tip or fall. To avoid personal injury or property damage, **ALWAYS** exercise common sense when cornering.

**Braking:** Your scooter is equipped with two powerful brake systems:

- (1) **Regenerative:** Uses the electricity generated in your scooter drive motor to rapidly slow your scooter when the speed direction lever is returned to the centre (neutral drive) stop position.
- (2) **Electric/Mechanical Disc Park Brake:** Located on the end of your drive motor it activates mechanically after the regenerative brake slows your scooter to a near stop, or when power is removed from the drive system for any reason, as in the case of switching your machine off.

Brake engagement is far more abrupt at higher speeds. It is important that you anticipate when the brakes will engage and that you are braced for the resulting deceleration.



**Warning:** Your scooter can decelerate very quickly. **DO NOT** decelerate or turn abruptly when traveling at high speed unless absolutely necessary. If it is necessary to decelerate or turn abruptly when driving at high speed, brace yourself by gripping the steering handlebar tightly and positioning your feet firmly on the floorboard. Users who can not grip the handlebar tightly and/or place their feet firmly against the footboard should avoid deceleration from or turning abruptly at high speed, and therefore should avoid traveling at high speed. Failure to observe this warning could result in serious personal injury and property damage. **ALWAYS** brace yourself firmly when decelerating your scooter.

**Never drive down slopes at full speed, ALWAYS adjust your speed to the driving condition and allow for gradual descents on inclines.**

**Outdoor Driving Surfaces:** Your scooter is designed to provide optimum stability under normal driving conditions i.e. dry, level surfaces composed of concrete or asphalt. However dealer recognizes that there will be times when you will encounter other surfaces such as packed soil, grass and gravel. These surfaces may not be sound and fail to give good traction, caution should be considered before driving on this type of surface to prevent stability problems resulting in injury or damage to your scooter.

- (1) Reduce your scooter's speed to the "Low" switch position when driving on uneven terrain or soft surfaces.
- (2) Avoid long and unsafe grass that can become tangled in the running gear or may hide debris and holes.
- (3) Avoid snow, this can quickly build up around your wheels.
- (4) Avoid loosely packed sand and gravel.
- (5) If you feel unsure about a driving surface, please anticipate and avoid that surface.

### Street And Roadway Driving:



**Warning:** Your scooter has been designed for operation on public streets and roads. It is also designed for operation on pedestrian pavements and traffic free shopping areas.

Your scooter must be driven with due care and compliance with the Road Traffic Acts and conditions of the Highway Code. **ALWAYS** obey all local pedestrian traffic rules. Wait until your path is clear of traffic, and then proceed with extreme caution.

*Note: **ALWAYS** wear light or illuminating clothing when driving your scooter. Be aware that it may be difficult for traffic to see you when you are seated on your scooter. **ONLY** drive your scooter on the road when a public pavement is available (i.e. in the countryside) or when crossing the roadway from one pavement to another.*

**Insurance:** Although at this moment in time it is not a legal requirement for accident insurance cover (third party), it is a sensible precaution. Your authorised dealer will be able to give you details of specialist insurance companies or your own insurance company will be able to advise you.

### Weather Precautions:



**Warning:** Dealer recommends that you **DO NOT** operate your scooter in icy or slippery conditions or on salted surfaces i.e. Roads and Pavements etc. Such use may result in accident, personal injury or adversely affect the performance and safety of your scooter.



**Warning:** Dealer recommends that you **DO NOT** expose your scooter to any type of heavy moisture at any time i.e. rain, snow or power washer. Such exposure can damage your scooter. Never drive through deep water or expose your scooter to sea water.

*Note: Salt is very corrosive to metal and electronic components. Following use in winter or exposure to sea sand and water, your scooter should be washed with a mild soap and water to remove all ingress of salts.*



**Warning:** **DO NOT** use a power hose. **DO NOT** operate your scooter if it has been exposed to moisture, until it has been thoroughly dried out.

**Motor Vehicle Transportation:** Currently there are no standards approved for "tie down" systems in a moving vehicle of any type to transport a person while seated in a scooter. Although your scooter may be equipped with a belt, this is not designed to provide proper restraint during motor vehicle movements. Anyone traveling in a motor vehicle should be properly secured in the motor vehicle seat with a safety belt fastened securely.



**Warning: DO NOT** sit on your scooter while it is in a moving vehicle. Personal injury may result.



**Warning: ALWAYS** make certain that your scooter is properly secured when being transported. Failure to comply may result in personal injury and/or damage to your scooter.

**Accessing Your Scooter:** Getting on and off your scooter requires a good sense of balance. Please observe the following tips when getting on and off your scooter.

- (1) Make certain your scooter is switched off at the power switch, and the power key is removed.
- (2) Ensure your scooter is not in the freewheel mode.
- (3) Make certain the seat and handlebars are locked firmly into position.
- (4) The seat armrests can be lifted up to make access easier. Make certain you **DO NOT** attempt to drive with the armrests raised.



**Warning:** Position yourself as far back into the scooter seat as possible to prevent tripping and causing injury.



**Warning:** Avoid using the armrests for weight bearing purposes, such use may cause the scooter to tip and cause personal injury and/or damage to the scooter.



**Warning:** Avoid putting weight onto the steering handlebars, such use may cause the scooter to tip and cause personal injury and/or damage to the scooter.



**Warning:** Avoid putting all of your weight onto the footboard, such use may cause the scooter to tip and cause personal injury.

**Modifications:** we has designed your scooter to provide maximum mobility. A range of accessories are available from authorised dealer, to further customise your scooter needs. However, under no circumstances should you modify, add, remove or disable any feature, parts or function of your machine.



**Warning:** Failure to observe this warning may result in personal injury and/or damage to your scooter.

**Inclines:** More and more modern buildings are designed with disability access in mind. Ramps have specified percentage of designed for easy and safe access. Some ramps may have turning switchbacks (180 degree turns) that require you to have good cornering skills on your scooter.

- (1) Proceed with extreme caution as you approach the downgrade of a ramp or other incline, sit right back in Your seat, brace your arms on the handlebars and your feet on the floorboard.

- (2) Take a wide arc with your scooter's front wheels around tight corners, your rear wheels will follow preventing you from cutting the corner short and bumping or getting hung up on raised kerbs.
- (3) When descending an incline keep your speed adjustment set to the slowest speed setting to ensure a safely controlled descent and driving in a forward direction **ONLY**. If your scooter descent is quicker than you anticipated allow the scooter to completely stop, then progress at a slower speed setting.



**Warning:** Never drive down an incline at full speed.

- (4) When climbing an incline, try to keep your scooter moving, if you must stop, start up again slowly and then accelerate smoothly with caution. Avoid sudden stop starts, lean forward towards your handlebars to increase stability and prevent rearward tripping.



**Warning:** When climbing an incline, **DO NOT** zig-zag or drive at an angle up the face of the incline. Drive your scooter smoothly up the incline without stopping, this greatly reduces the possibility of a tip or fall.



**Warning:** You should not travel over a potentially hazardous incline i.e. areas covered with ice or snow, cut grass or wet leaves or any unstable surface.



**Warning:** **DO NOT** overload your scooter, at the rear when climbing an incline. **ALWAYS** lean forward to provide the best stability and prevent rearward tripping.



**Warning:** Any attempt to climb or descend an incline steeper than shown in the scooter specification at the rear of this manual may put your scooter in an unstable position and cause it to tip resulting in personal injury.

*Note: Never remove the anti-tip wheels of your scooter, they are an important part of your scooter design.*

#### Stairs And Escalator:



**Warning:** Scooters are not designed to travel up or down stairs or escalators. **ALWAYS** use an elevator. Failure to observe this warning may result in injury to yourself and others and damage your scooter.

#### Preventing Unintended Movement:



**Warning:** If you anticipate being seated in a stationary position for an extended period of time turn off the power key switch, this will prevent unexpected motion due to inadvertent movement of the direction control lever. Failure to observe this warning may result in personal injury.

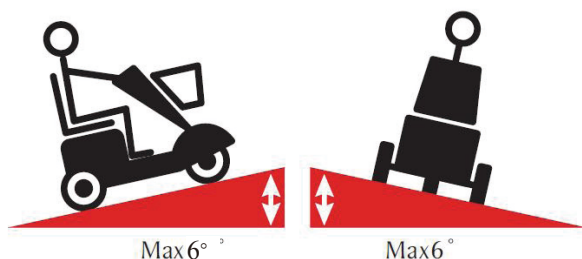

#### Disposal Of Elector-mobile Scooter:

In time when your scooter becomes unusable it must be disposed of in accordance with the laws implemented at that time. For further information regarding the recycling arrangements for this type of vehicle and its batteries, contact your local authority or government department,

details of this can be found in your telephone directory or your approve dealer .

# SAFETY WARNING & INSTRUCTION LABELS

The following labels are positioned on your scooter, they communicate important warnings or instructions regarding the safe operation of your scooter. Please familiarise yourself with their location.



Control console label



Located on right of handlebar cover



Located at the left or right hand rear cover

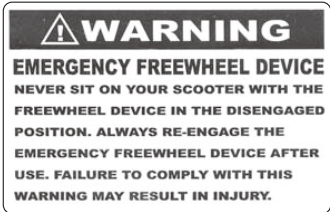

Located on the top of the scooter's rear cover

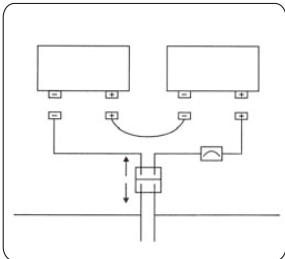

Wiring diagram for batteries located under rear cover



Located at right rear of handlebars near charging socket

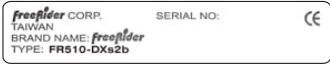

Data serial plate located on front wheel cross member



Located on the top leftside of the rear cover

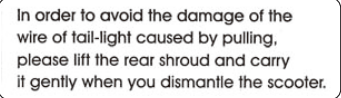

Yellow label located on the top of the rear cover



## LEARNING TO GET ABOUT

### 1. Basic Driving:

Make certain you are comfortably seated on your scooter and both armrests are down. Ensure that the "Speed Adjustment Dial" is turned to minimum for your first drive. When you have become more confident you can increase the setting to a higher speed. Push the right "Thumb Lever Control" as described earlier. You will very gently move forwards. Release the lever, and you will gently stop. Practice these two basic functions until you get used to them. Steering the scooter is easy and logical by turning the handlebars in the direction you wish to maneuver.

### 2. Incline Control:

When you approach an incline, it is best to lean forward. This moves the center of gravity of your scooter towards the front of the scooter for improved stability. When going down an incline, keep your speed slow. This will keep you in a safely controlled descent. It is best to lean backwards; this moves the center of gravity of your scooter towards the rear of the scooter for improved stability. If you wish to stop completely, release the control lever, and you will come to a gentle stop, avoid sudden stop or starts.

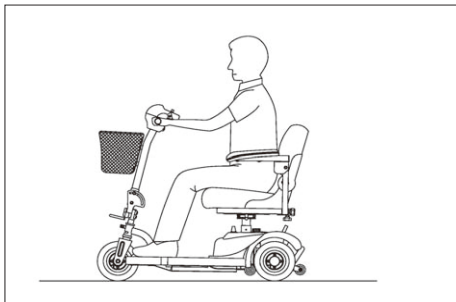

Normal driving position

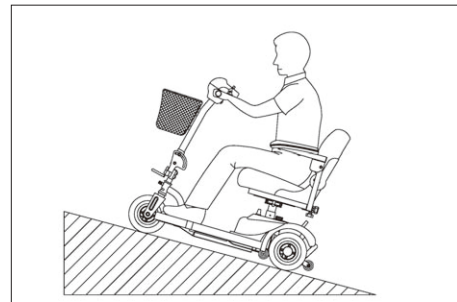

Increased Stability driving position

### 3. Control Over Stationary Obstacles:

Stationery obstacle (steps, curbs etc.) must be avoided where possible. Proceed with extreme caution when driving near raise surfaces, unprotected ledges and/or drop offs such as curbs, porches, stairs etc.

Most new pavements have wheelchair access ramps at intersections, use these at all times. Plan your route where possible to avoid poor and uneven surfaces. **DO NOT** attempt to ride up or down curbs as you may ground your scooter and damage it's construction.

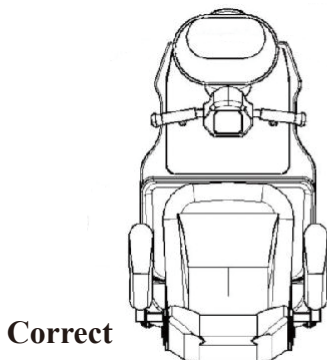

Correct



Incorrect

#### 4. Control Over Grass & Gravel ETC.

Care must be taken when attempting to drive over soft surfaces such as those found in parks etc. The surface may look level, but this can be deceiving and hidden dangers may make your scooter become unstable or grounded. Avoid unkempt grass, loose deep gravel or sand. **DO NOT** exceed the capabilities of your scooter. **ALWAYS** have an attendant to assist you in circumstances where you are not certain of the terrain. **ALWAYS** anticipate and think safety.



**Caution:** Because of the power of your scooter, you will be able to climb inclines. But the maximum safe gradient limit is 6 degree. The reason for this is to ensure good stability.

**ALWAYS** have the anti-tipping wheels fitted to your scooter. They are an important part of your scooters design and reduce the likely hood of backward tipping.

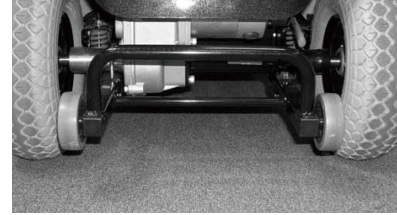

**ALWAYS** avoid where possible turning on slopes or climbing curbstones. **ALWAYS** make certain that your scooter is in full working order and your batteries are fully charged before attempting to drive. Never attempt to drive beyond the design capability of your scooter. Observe weather conditions. Tyres can slip on wet or icy surfaces.

**DO NOT DRIVE THROUGH DEEP WATER OR LEAVE YOUR SCOOTER EXPOSED TO HEAVY RAIN.**

i.e. During or after a thunderstorm.

**DO NOT** attempt to turn when negotiating an incline, **ONLY** turn when all wheels are fully on or off the incline; failure to observe this warning could result in the machine becoming unstable and toppling over. **ALWAYS** lean forward when ascending an incline and backwards when descending an incline. This will enable you to maintain good stability and will eliminate any chance of a rear or forward upset.

*Note: The rear stability of your scooter is dependent on a number of factors which you should consider before attempting to climb an incline or other obstacle:*

- (1) Your height;
- (2) The height of your seat;
- (3) Your weight;
- (4) The angle of the incline you are attempting to climb.

All of these factors can affect the rear stability of your scooter. If you are unsure of your capability to climb an obstacle, then try another route.

**ALWAYS think "safety first".**



## CARE & MAINTENANCE

Your scooter, like any other electro-mechanical machine, will benefit from regular servicing by your dealer. You too, can help keep your scooter in good condition by following a simple guide to home maintenance.

*Note: **ONLY** competent people should carry out service work.*

### **Seat Upholstery:**

A damp cloth and a little soapy water will keep your seat, backrest and arms looking smart. **DO NOT** use abrasive cleaners as this will damage the coating. Upholstery can be damaged by chemical cleaners.

The coating material can also degrade over a period of time due to contamination by natural oils in the hair and skin or from medicated power products. Ultra-violet light can also reduce the life of the upholstery coating material. This is a normal ageing process and cannot be guaranteed.

### **Bodywork:**

The painted bodywork on your scooter can be lightly washed with clean soapy water. **DO NOT** use abrasive cleaners or strong detergents. This could fade the color; shampoo for automobile works well. Remove salt contact as this is very corrosive to bright metal parts.



**Caution: DO NOT** hose down your scooter with a powerful cleaner. Water could be forced into the electronics and cause permanent damage. On the painted finish, be cautious not to wash with a dirty cloth as this could scratch the paint finish. Auto polish can be used to keep the paintwork and bright chrome parts in pristine condition.

The metal framework of your scooter should be cleaned twice a year and any paintwork damaged should be treated to prevent further attack from the elements. Wash regularly if contact is made with road or sea salt, this is very corrosive.

**DO NOT** store your scooter in damp conditions. This may affect the electronics if left for very long periods of time. Moisture, if left unattended can cause deterioration on metal work, protect with proprietary cleaners.

### **Electronics:**

Servicing of the drive electronics and charger should **ONLY** be carried out by your local service dealer. These units are sealed and should not be opened.

### **Driving Terrain and Limit:**

**DO NOT** operate your scooter in exceptional weather conditions, ie. very heavy rain or wind. Cover your machine up if it is to be left unattended and outside for a long period of time.

**DO NOT** drive through deep water with your scooter. This could damage the electronic speed controller. Sea and road salts are very corrosive and should be neutralized quickly.

### **Drive Transmission Lubrication:**

This unit is factory filled and will not normally need additional lubrication.

*Note: Your scooter transmission is filled with a special lubricant. **DO NOT** attempt to force grease into the transmission as this will contaminate the original lubrication and will invalidate your guarantee.*





**Caution:** Take care when handling the transmission, keep well away from clothing. It is normal to find a light film of lubrication around this part.

### Motor Brakes:

*Safety Note: For your own safety, we recommend that you check the function of your scooter brakes prior to a journey.*

Motor Brake: If the motor brake is functioning correctly and the drive is engaged you will not be able to push your machine when it is switched off. Or switched on with the speed control lever in the "zero speed", central position.



**Warning:** If your scooter can be pushed as described above, the motor brake could be faulty. Please **DO NOT** use, contact your local dealer.

*Note: Check the Freewheeling Instructions of this manual.*

### Driving Brake:



**Warning:** When you drive your scooter and you let go of the speed control lever your scooter should reduce speed very quickly. If you notice a change in the normal slowing/braking condition of your scooter and it does not slow down quickly, please **DO NOT** use your machine, and contact your local dealer.

### Tyres

Check the condition of your tyres regularly. Look for signs of wear, cuts and foreign objects lodged in the tread. Tyres should be replaced when the tread is worn to 0.5mm.





## BATTERIES & BATTERY CHARGING

### 1. Battery Installation:

Your scooter is equipped with two maintenance free 12 volt 36Ah or 50Ah batteries. The batteries are linked together by wiring cables to supply the electronic system with 24 volts of power.



**Warning:** It is imperative that the two batteries are connected correctly to prevent a short circuit between the two batteries. When first installing the batteries follow these assembly instructions.

- (1) Connect the labeled positive (+) wire to the positive (+) terminal of the battery, with the screw, nut and washer provided.
- (2) Connect the labeled negative (-) wire to the negative (-) terminal of the battery, with the screw, nut and washer provided.
- (3) Repeat this procedure on the second battery making certain the plastic red/black terminal covers are secured over each terminal.
- (4) Sit on the seat and switch on your scooter, the battery meter will now move to show the state of charge in the batteries and your scooter is ready to drive.

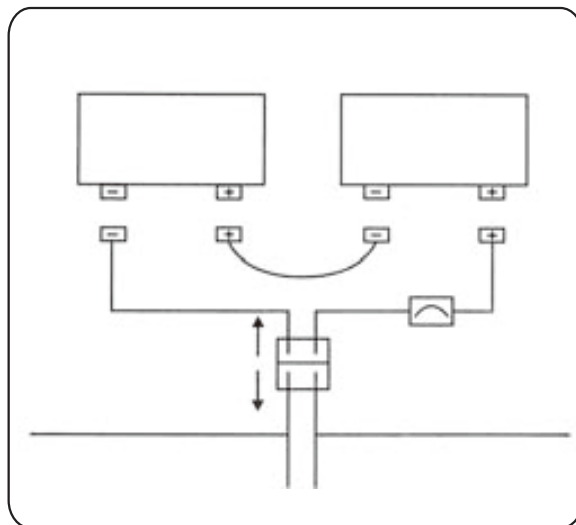

### 2. Battery Charging:

Your scooter has a lot of power. To ensure it works to its full potential you must maintain both batteries on full charge. Nightly recharging, after use, will help you to give them a longer life and will ensure your scooter is **ALWAYS** ready to go when you are. **ONLY** use the charger supplied with your scooter; other makes of charger may permanently damage your batteries and would invalidate the guarantee.

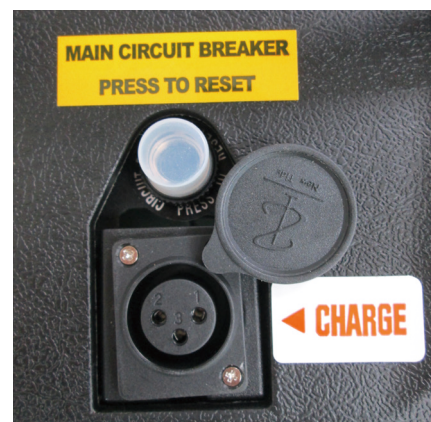



## BASIC FAULT FINDING

### If your scooter will not start:

- (1) Check that the power key switch is turned "on". If it is, the battery condition indicator meter will be operating. If the green status light on your console is flashing once per second, charge your batteries.

If the battery condition meter and the green status light fail to operate when the key switch is in the "on" position, check the following:

- (2) Make sure the battery charger is not plugged into the charge socket, this will prevent the scooter from driving.
- (3) Check both battery connectors. Check battery terminal condition.
- (4) Check the circuit breaker.

If your scooter stops for no apparent reason, it is probably due to the circuit breaker disconnecting from the speed control electronic box.

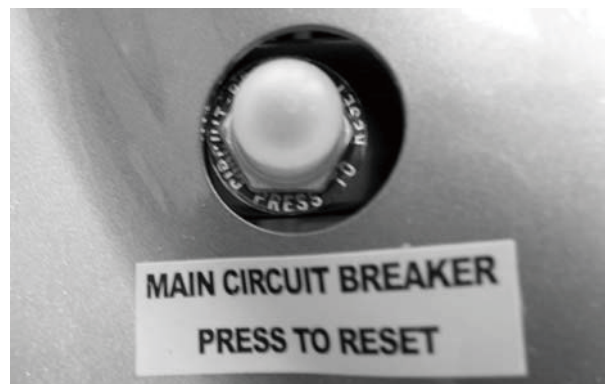

On rare occasions, a temporary overload on the electric circuit can occur – for instance when climbing a steep incline. If this happens, reset the circuit breaker, wait for two minutes to allow the temperature activated switch to cool down. Locate the plunger on the circuit breaker through the access hole. Place a finger onto the circuit breaker and press down on the plunger until it remains down. You are now ready to drive again. If the circuit breaker trips up again wait for 5 minutes and try again.

### 1. Fault Diagnosis:

Faults with the main speed controller are rare. Most faults on powered vehicles are associated with wiring or misconnections due to poor maintenance or incorrect installation of connectors when assembling the scooter after transportation in a car.

If your scooter should fail to operate, you will be assisted in diagnosis and locating the area of the fault by observing the number of flashes emitted from the "green" status light on your control console.

## 2. Charging Circuit Fuse:

One fuse protects your scooter charging circuit from receiving an overload of electrical current. The fuse used in the scooter is the same type which is found on automobiles. In the unlikely event that a fuse should "blow" and needs replacing.

Use **ONLY** a fuse of same amp rating on your scooter. Please note this size of fuse has been selected to give your scooter the best protection without premature fusing.



**Warning: DO NOT** use fuses with a higher rating than origin amps as this may cause permanent failure to the wiring and wiring connectors or personal injury. For access to a fuse remove the screws located in the battery box cover, and then lift the cover.

Locate and lift the fuse block on its wire, lift up the fuse lid and withdraw the "red" fuse. Replace the blown fuse with same amp rating fuse, close fuse lid and replace fuse block.

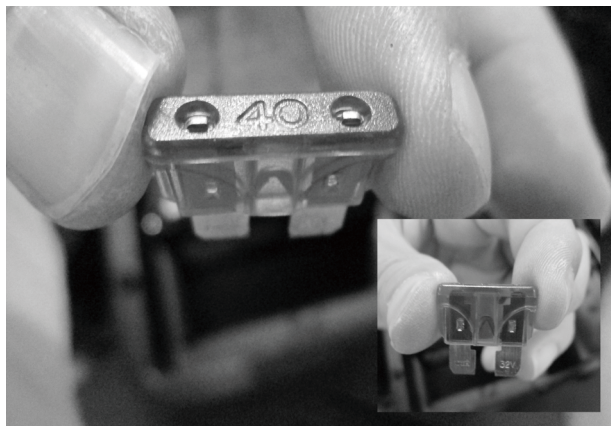

The scooter **ONLY** uses a fuse of same amp rating. Please note this size of fuse has been selected to give your scooter the best protection without premature fusing.

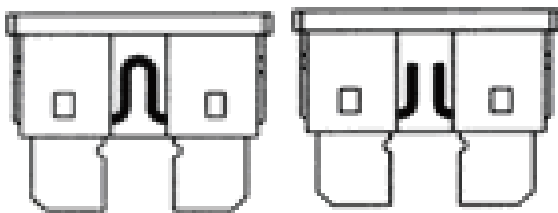

### 3. Status Fault Codes

FLASH	Description	Meaning
1	Battery Low	The batteries are running low. ●Recharge the batteries.
2	Low Battery Fault	The batteries have run out of charge. ●Recharge the batteries. ●Check the battery and associated connections and wiring.
3	High Battery Fault	Battery voltage is too high. This may occur if overcharged &/or travelling down a long slope. ●If travelling down a slope, reduce your speed to minimise the amount of regenerative charging.
4	Current Limit Time-out	The motor has been exceeding its maximum current rating for too long. ●The scooter may have stalled. Turn the controller off, leave for a few minutes and turn back on again. ●The motor may be faulty. Check the motor and associated connections and wiring.
5	Park Brake Fault	Either a park brake release switch is active or the park brake is faulty. ●Check the park brake and associated connections and wiring. ●Ensure any associated switches are in their correct positions.
6	Throttle OONAPU (Out Of Neutral At Power Up)	Either a stop function is active or a charger inhibit or OONAPU condition has occurred. ●Release the Stop condition (seat raised etc.) ●Disconnect the battery charger ●Ensure the throttle is in neutral when turning the controller on. ●The throttle may require re-calibration.
7	Speed Pot Fault	The throttle, speed limit pot, their associated wiring may be faulty. ●Check the throttle and speed pot and associated connections and wiring.
8	Motor Voltage Fault	The motor or its associated wiring is faulty. ●Check the motor and associated connections and wiring.
9	Other Error	The controller may have an internal fault. ●Check all connections and wiring.



## TECHNICAL SPECIFICATION

<b>Model Number</b>	<b>FR168-3/3S (FR-S01)</b>
Maximum Safe Slope	6 degree
Maximum Climbing Ability	6 degree
Overall Length* <sup>2</sup>	113 cm (44.5 inches)
Overall Width* <sup>2</sup> at wheels	61.5 cm (24.2 inches)
Total Weight with Batteries	72 kg (158.4 lbs.) for 36Ah
Total Weight Without Batteries	50 kg (110.00 lbs.)
Battery Weight (Each)* <sup>4</sup>	11 kg (24.2 lbs.) for 36Ah
Turning Radius	94 cm (37 inches)
Speed (Maximum)* <sup>1</sup>	168-3 -4 mph (6.4 kph) 168-3S -6 mph (9.6 kph)
Range Per Charge* <sup>1</sup> * <sup>5</sup>	12 miles (19.0 km) for 36Ah
Ground Clearance	8 cm (3.2 inches)
Weight Capacity	300 lbs. (136 kg)
Standard Seating	Type: Foldable Weight (w/armrests): 16 kg (35.2 lbs.) Dimensions: 18.5 inches (47 cm) depth 18.5 inches (47 cm) width
Drive System	Rear-wheel drive, sealed transaxle, 24 volt DC motor
Dual Braking System	Electronic, regenerative, and electromechanical
Tyres	Type: Pneumatic or PU solid Front & Rear 10 inches (25.4 cm)
Battery Requirements* <sup>3</sup>	Type: 12 volt, deep cycle, AGM Size: 36Ah QTY: 2
Battery Charger	5-amp charger

Please view the " \* " mark at page.32

Note: All specifications subject to change without notice.

<b>Model Number</b>	<b>FR168-4 (FR-S03)/FR168-4S (FR-S04)</b>
Maximum Safe Slope	6 degree
Maximum Climbing Ability	6 degree
Overall Length* <sup>2</sup>	125.6 cm (49.44 inches)
Overall Width* <sup>2</sup>	168-4 - 58 cm (22.83 inches) at rear wheels 168-4S - 63 cm (24.8 inches) at rear wheels
Total Weight with Batteries	168-4 - 184.36 lbs. (83.8 kg) for 36 Ah 168-4S - 211.64 lbs. (96.2 kg) for 50Ah
Total Weight Without Batteries	168-4 - 136 lbs. (61.8 kg) for 36 Ah 168-4S - 145.6 lbs. (66.2 kg) for 50Ah
Battery Weight (Each)* <sup>4</sup>	11 kg (24.2 lbs.) for 36Ah 15 kg (33 lbs.) for 50Ah
Turning Radius	168-4 - 148.85 cm (58.6 inches) 168-4S - 143.75 cm (56.6 inches)
Speed (Maximum)* <sup>1</sup>	168-4 -4 mph (7 kph) 168-4S -6 mph (9.6 kph)
Range Per Charge* <sup>1</sup> * <sup>5</sup>	168-4 -12 miles (19.0 km) for 36Ah at 300lbs 168-4S -19 miles (30.0 km) for 50Ah at 300lbs
Ground Clearance	168-4 - 4.7 cm (1.85 inches) 168-4S - 7 cm (2.8 inches)
Weight Capacity	300 lbs. (136 kg)
Standard Seating	Type: Foldable Weight (w/armrests): 16 kg (35.2 lbs.) Dimensions: 17.13 inches (43.5 cm) depth 16.46 inches (41.8 cm) width
Drive System	Rear-wheel drive, sealed transaxle,24 volt DC motor
Dual Braking System	Electronic, regenerative, and electromechanical
Tyres	Type: Pneumatic or PU solid FR168-4 Front & Rear 10 inches (25.4 cm) FR168-4S Front 10 inches (25.4 cm) & Rear 12 inches (30.48 cm)
Battery Requirements* <sup>3</sup>	Type: 12 volt, deep cycle, AGM Size: 168-4 - 36 Ah 168-4S - 50 Ah QTY: 2
Battery Charger	5-amp charger

**Please view the " \* " mark at page.32**

*Note: All specifications subject to change without notice.*

<b>Model Number</b>	<b>FR510DX2 (FR-D01) /510DXs2 (FR-D02)</b>
Maximum Safe Slope	6 degree
Maximum Climbing Ability	10 degree
Overall Length* <sup>2</sup>	143.5 cm (56.5 inches)
Overall Width* <sup>2</sup> at wheels	63 cm (24.8 inches)
Total Weight with Batteries	103.8 kg (228.36 lbs.) for 50 Ah
Total Weight Without Batteries	73.8 kg (162.36 lbs.)
Battery Weight (Each)* <sup>4</sup>	15 kg (33 lbs.) for 50 Ah
Turning Radius	147 cm (57.87 inches)
Speed (Maximum)* <sup>1</sup>	6 mph (9.6 kph)
Range Per Charge* <sup>1</sup> * <sup>5</sup>	26.25 miles (42 km) for 50 Ah
Ground Clearance	9.5cm (3.74 inches)
Weight Capacity	400 lbs. (181 kg)
Standard Seating	Type: Foldable Weight (w/armrests): 17 kg (37.4 lbs.) Dimensions: 16.93 inches (43 cm) depth 17.91 inches (45.5 cm) width
Drive System	Rear-wheel drive, sealed transaxle,24 volt DC motor
Dual Braking System	Electronic, regenerative, and electromechanical
Tyres	Type: Pneumatic or PU solid Front & Rear 13 inches (32 cm)
Battery Requirements* <sup>3</sup>	Type: 12 volt, deep cycle, AGM Size: 50 Ah QTY: 2
Battery Charger	5-amp charger

**Please view the " \* " mark at page.32**

*Note: All specifications subject to change without notice.*



<b>Model Number</b>	<b>FR168-4S2B (FR-S06)</b>
Maximum Safe Slope	6 degree
Maximum Climbing Ability	6 degree
Overall Length* <sup>2</sup>	135.2 cm (53.22inches)
Overall Width* <sup>2</sup> at wheels	63.5 cm (25 inches)
Total Weight with Batteries	102.6 kg (225.72 lbs.) for 50 Ah
Total Weight Without Batteries	72.6 kg (159.72 lbs.)
Battery Weight (Each)* <sup>4</sup>	15 kg (33 lbs.) for 50 Ah
Turning Radius	151.2 cm (59.52 inches)
Speed (Maximum)* <sup>1</sup>	8 mph (12.8 kph)
Range Per Charge* <sup>1</sup> * <sup>5</sup>	35 miles (56.0 km) for 50 Ah
Ground Clearance	7 cm (2.75 inches)
Weight Capacity	300 lbs. (136 kg)
Standard Seating	Type: Foldable Weight (w/armrests): 16 kg (35.2 lbs.) Dimensions: 17.52 inches (44.5 cm) depth 18.11 inches (46 cm) width
Drive System	Rear-wheel drive, sealed transaxle,24 volt DC motor
Dual Braking System	Electronic, regenerative, and electromechanical
Tyres	Type: Pneumatic or PU solid Front 10 inches (25.4 cm) & Rear 12 inches (30.48 cm)
Battery Requirements* <sup>3</sup>	Type: 12 volt, deep cycle, AGM Size: 50 Ah QTY: 2
Battery Charger	5-amp charger

**Please view the " \* " mark at page.32**

*Note: All specifications subject to change without notice.*

- \*1. Varies with user weight, terrain type, battery amp-hour (Ah), battery charge, battery condition and tyre condition.  
These specifications can be subject to a variance of (+/- 10%).
- \*2. Due to manufacturing tolerances and continual product improvement, this specification can be subject to a variance of (+ or - 3%).
- \*3. AGM battery required.
- \*4. Battery weight may vary based on manufacturer.
- \*5. Tested in accordance with ANSI/RESNA, WC Vol2, section 4 & ISO 7176-4 standards. Results derived from theoretical calculations based on battery specifications and drive system performance test conducted at maximum weight capacity.

### **Features**

- **Delta tiller with wraparound handles**
- **Exclusive stylish, lightweight, non-scuffing, black, low-profile wheels**
- **Easy access tiller-mounted charger port**

### **Options**

- **Combined Basket, Stick/Crutch holder**
- **Stick/Umbrella holder**
- **Oxygen tank holder**
- **Saddle (Seat) bag**

The information contained herein is correct at the time of publication; we reserve the right to alter specifications without prior notice. Speed & range vary with user weight, terrain type, battery charge, battery condition and tyre pressure. Due to manufacturing tolerances and continual product improvement, length, width, turning radius and ground clearance can be subject to variance of + or - 3 %.



## CLASSIFICATION

Type "B" indoor / with some outdoor capabilities (EN12184) Class 2 (Highway Regulations 1988).

**Maximum safe climbing angle:** 6 degree



**Warning:** The safe climbing angle is measured with the seat in the highest position, and maximum weight capacity. The motor on your scooter is powerful and may be able to climb a steeper incline than the maximum safe climbing angle. Exceeding the safe climbing angle may put you at risk of injury. On no account must you attempt to climb an incline of more than 6 degree. This will exceed the rear stability of your scooter.

**Range Per Charge:**

1. FR-S01/S03 (36Ah), 12 miles (19.0km)
2. FR-S04 (50Ah), 19 miles (30km)
3. FR-D01/D02 (50Ah), 26.25 miles (42km)
4. FR-S06 (50Ah), 35 miles (56km)

*Note: Range varies with weight, terrain, temperature, battery condition etc. and is subject to manufacturing tolerances. Your battery will require a period of "breaking in" before they will reach their optimum capacity (up to 20 charge, discharge cycles can be expected) before full range is experienced. Refer to the battery charging section of this manual.*

**Tire Size:**

1. FR-S01/S03, Front & Rear 10inches (25.4cm)
2. FR-S04, Front 10 inches (25.4cm) & Rear 12 inches (30.48cm)
3. FR-D01/D02, Front & Rear 13 inches (32cm)
4. FR-S06, Front 10 inches (25.4cm) & Rear 12 inches (30.48cm)

**Batteries:** AGM battery FR-S01/S03 with 36Ah and FR-S04/S06/D01/D02 with 50Ah

**Charger:** AC input. 100-240 volt, 50/60Hz  
DC output 24 volt. 5 Amp for AGM battery  
Conforms to: EN60335-2-29 and  
EN12184  
EN55022, Class B  
IEC61000-4-2/ IEC61000-4-3

**EMI/RFI:** Field strength tested to 20V/m compliance

**Electrical System:** 24 volt DC

**Drive System:** Rear wheel, direct drive via sealed drive axle

**Motor:** 24 volt DC



## OPTIONAL ACCESSORIES

For information and installation method regarding these optional accessories please contact your authorised dealer. (**Dealer information please refer to the back cover**)

### REAR BASKET



Provides easily accessible additional carrying capacity for shopping. Basket maximum load 4kg (9lbs).

### LOCKABLE STORAGE BOX



This smart storage box allows you to lock away your valuable items when leaving your scooter unsupervised. Maximum load 2kg (4.5lbs).

### STICK/UMBRELLA HOLDER



Ideal way to carry walking aids.

### DELTA CONTROLLER



For scooter users with limited hand dexterity. Allows the user to control the scooter by pulling the lever toward themselves.



## GUARANTEE TERMS

**Please keep a note of your serial number.**

(This is located on the front frame tube, under the front chassis cover).



Your scooter is guaranteed for 12 months from the date of purchase against faults arising due to defects in manufacture or materials. This guarantee does not detract from, but is in addition to your legal rights. Parts replaced or repaired under the terms of this guarantee will be covered for the balance of the 12 months period.

This guarantee applies **ONLY** to parts supplied or approved by authorised dealer.

This guarantee is not transferable.

*Note: Extended guarantee insurance can be arranged by your dealer. The dealer will be able to advise the extra cost for extended guarantee insurance.*

### **METAL WORK:**

Metal components, such as the framework and bright metal parts require special attention and may deteriorate in certain conditions. Moisture and salt may corrode parts left unattended, proprietary auto cleaner polishes should be used to prevent long term damage. Failure to clean and protect these components may void your warranty.

### **SPEED CONTROLLER:**

Servicing of the speed controller or battery charger must **ONLY** be carried out by your local authorised distributor. Any attempt to open or dismantle these items render the guarantee void on that item.

### **BATTERIES:**

Batteries carry a limited 12 month guarantee from the original manufacturer which is subject to a stringent wear and tear clause. Any battery faults due to a defect in the original manufacture will normally become obvious within the first two months of use. Any gradual deterioration in the performance after this period is normal and associated with fair wear and tear, misuse or accidental damage and as such is not covered by the manufacturers warranty. (Batteries are guaranteed as single parts, **ONLY** the failed part is replaceable)



**Warning: DO NOT** attempt to open the battery vent plugs.



## SERVICE HISTORY

This section is designed to assist you in keeping a record of any service and repairs to your scooter. If you decide to sell or exchange your scooter in the future, this will prove most helpful to you. Your service dealer will also benefit from a documented record and this book should accompany the scooter when service or repair work is carried out. The service dealer will complete this section and return the book to you.

DETAILS OF WORK CARRIED OUT	DEALER STAMP
	DATE                      INITIALS

DETAILS OF WORK CARRIED OUT	DEALER STAMP
	DATE                      INITIALS

DETAILS OF WORK CARRIED OUT	DEALER STAMP
	DATE                      INITIALS

DETAILS OF WORK CARRIED OUT	DEALER STAMP
	DATE                      INITIALS

DETAILS OF WORK CARRIED OUT	DEALER STAMP		
	<table border="1"> <tr> <td data-bbox="752 470 909 534">DATE</td> <td data-bbox="909 470 1326 534">INITIALS</td> </tr> </table>	DATE	INITIALS
DATE	INITIALS		

DETAILS OF WORK CARRIED OUT	DEALER STAMP		
	<table border="1"> <tr> <td data-bbox="752 812 909 876">DATE</td> <td data-bbox="909 812 1326 876">INITIALS</td> </tr> </table>	DATE	INITIALS
DATE	INITIALS		

DETAILS OF WORK CARRIED OUT	DEALER STAMP		
	<table border="1"> <tr> <td data-bbox="752 1153 909 1217">DATE</td> <td data-bbox="909 1153 1326 1217">INITIALS</td> </tr> </table>	DATE	INITIALS
DATE	INITIALS		

DETAILS OF WORK CARRIED OUT	DEALER STAMP		
	<table border="1"> <tr> <td data-bbox="752 1495 909 1559">DATE</td> <td data-bbox="909 1495 1326 1559">INITIALS</td> </tr> </table>	DATE	INITIALS
DATE	INITIALS		

DETAILS OF WORK CARRIED OUT	DEALER STAMP		
	<table border="1"> <tr> <td data-bbox="752 1836 909 1900">DATE</td> <td data-bbox="909 1836 1326 1900">INITIALS</td> </tr> </table>	DATE	INITIALS
DATE	INITIALS		

**YOUR LOCAL DEALER**  
(TO BE FILLED IN BY LOCAL DEALER)

***freerider***<sup>®</sup>

**FREERIDER CORP.**

Head Quarter and Kaohsiung Facility:  
No.22, Bengong 5th Rd., Gangshan Dist.,  
Kaohsiung City 820, Taiwan(R.O.C)  
Tel:886-7-6223093 Fax:886-7-6230373  
Email: sales@freerider.com.tw  
<http://www.freerider.com.tw>  
<http://www.luggie.com.tw>

2021.2.17 V5



PL90-0200